

# SIGNATURE SERIES 3300 ED

## Dimensions

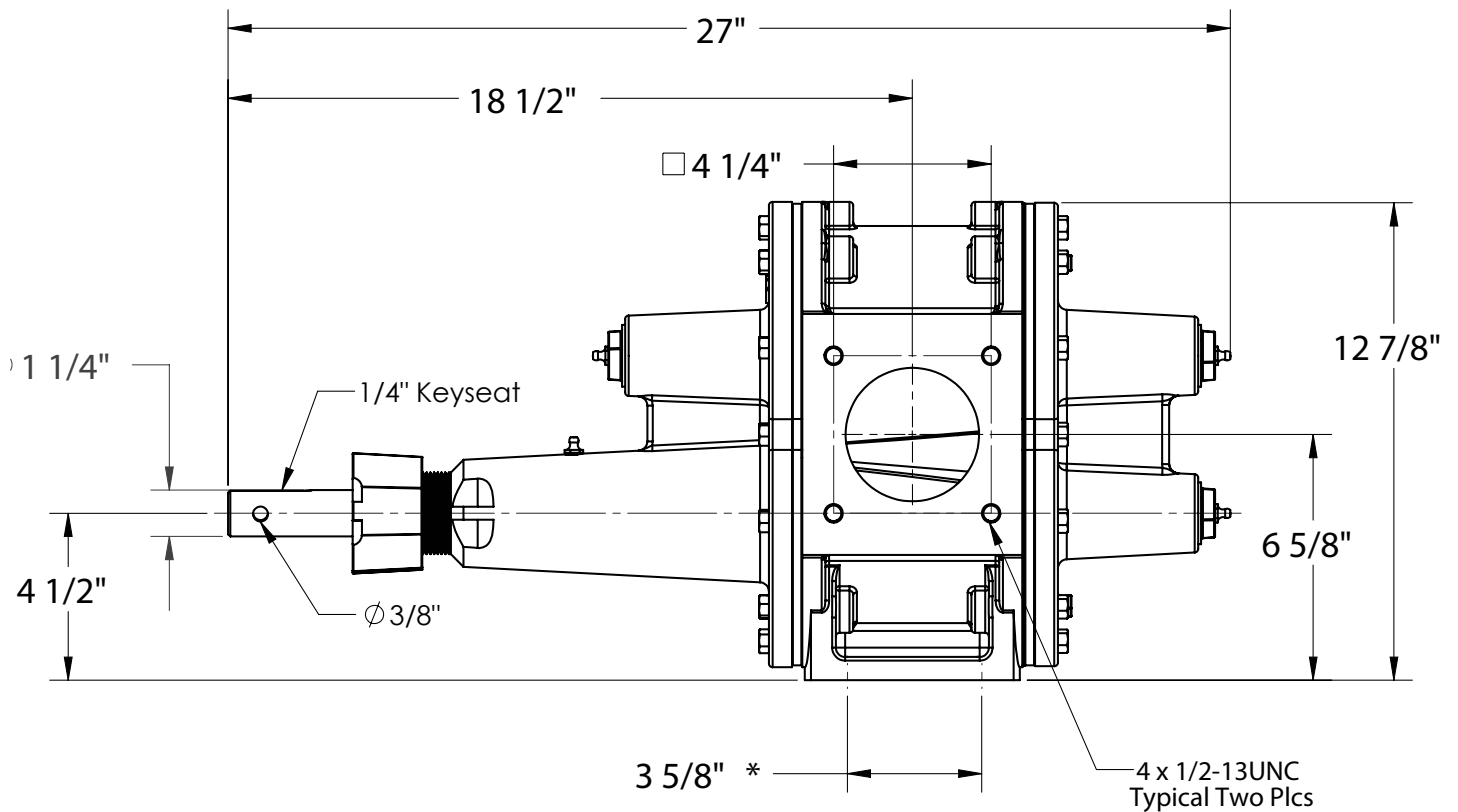
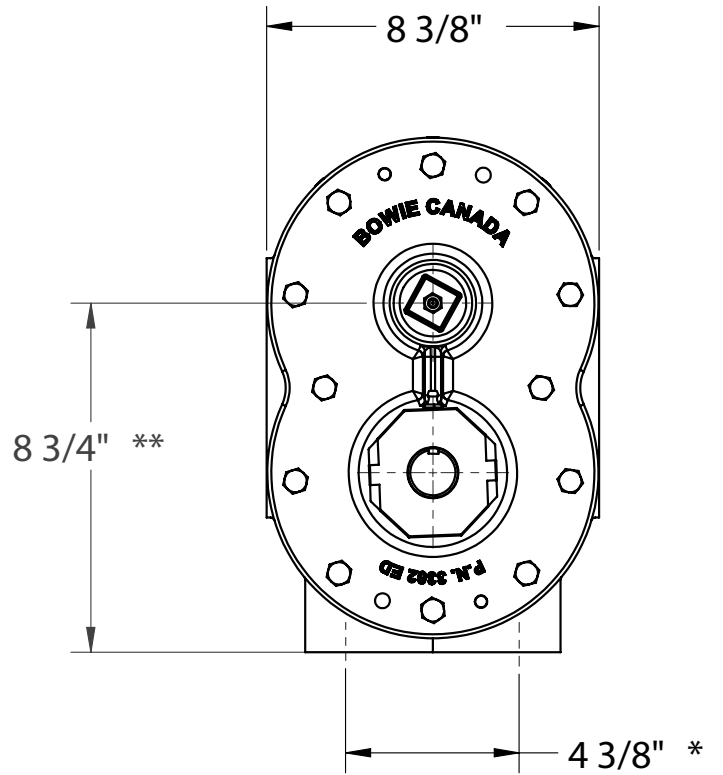
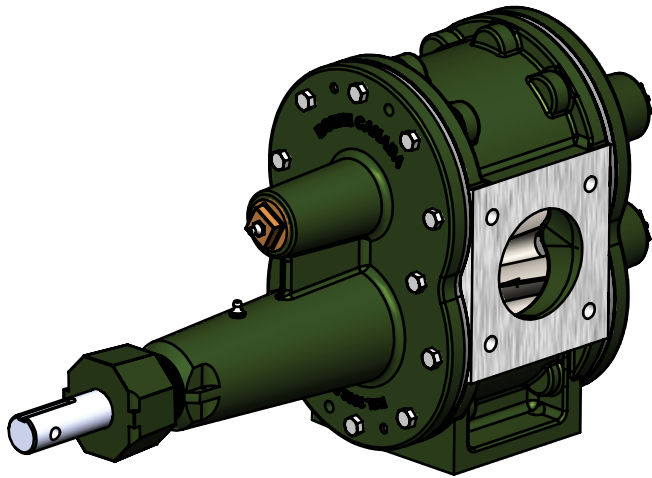

FOR REFERENCE: BASE BOLT PATTERN 4 x 1/2-13 UNC

DRIVE "ON TOP" APPLICATION IS AVAILABLE;  
 "LEFT" & "RIGHT" configurations are shown;

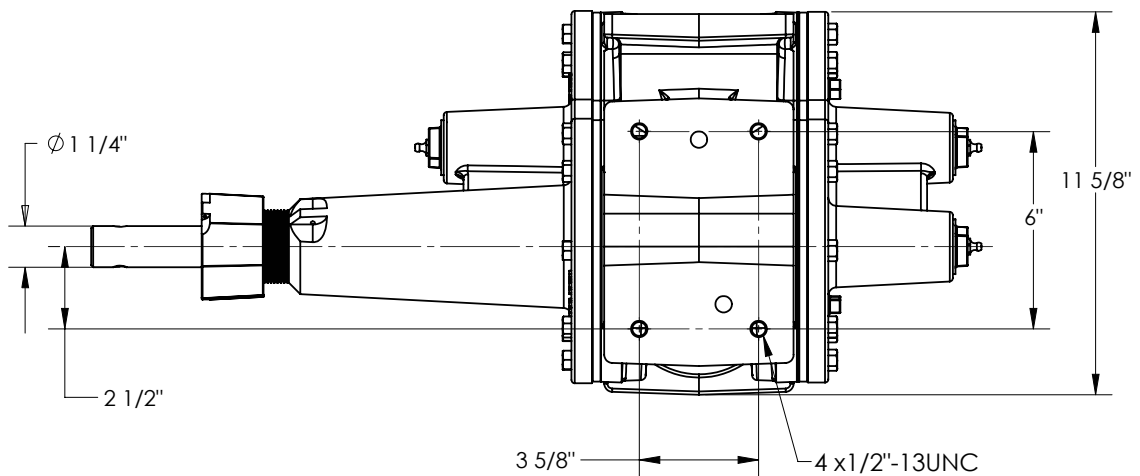
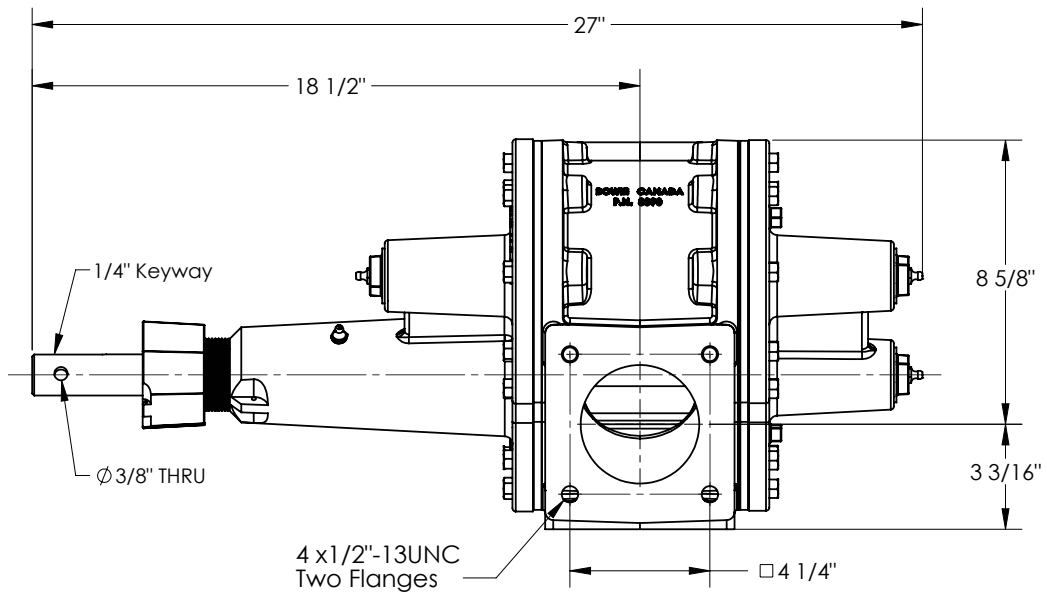
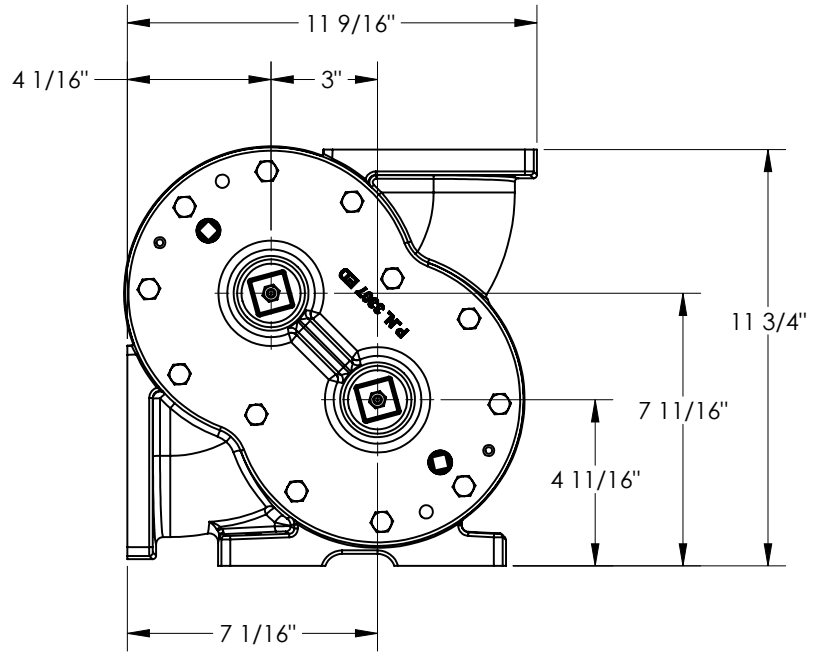
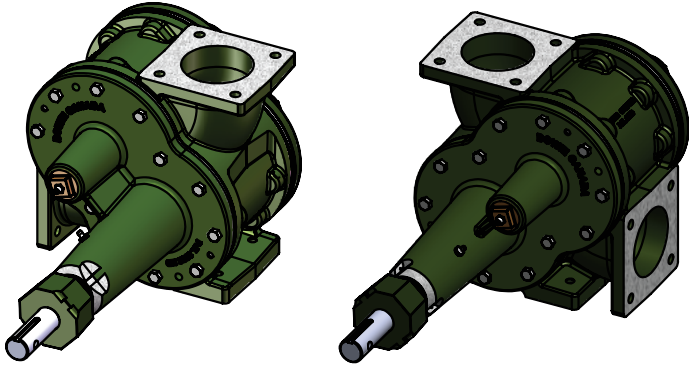

**BOTTOM VIEW**