

ULTRA-SEAL™ SERIES 4600

Dimensions

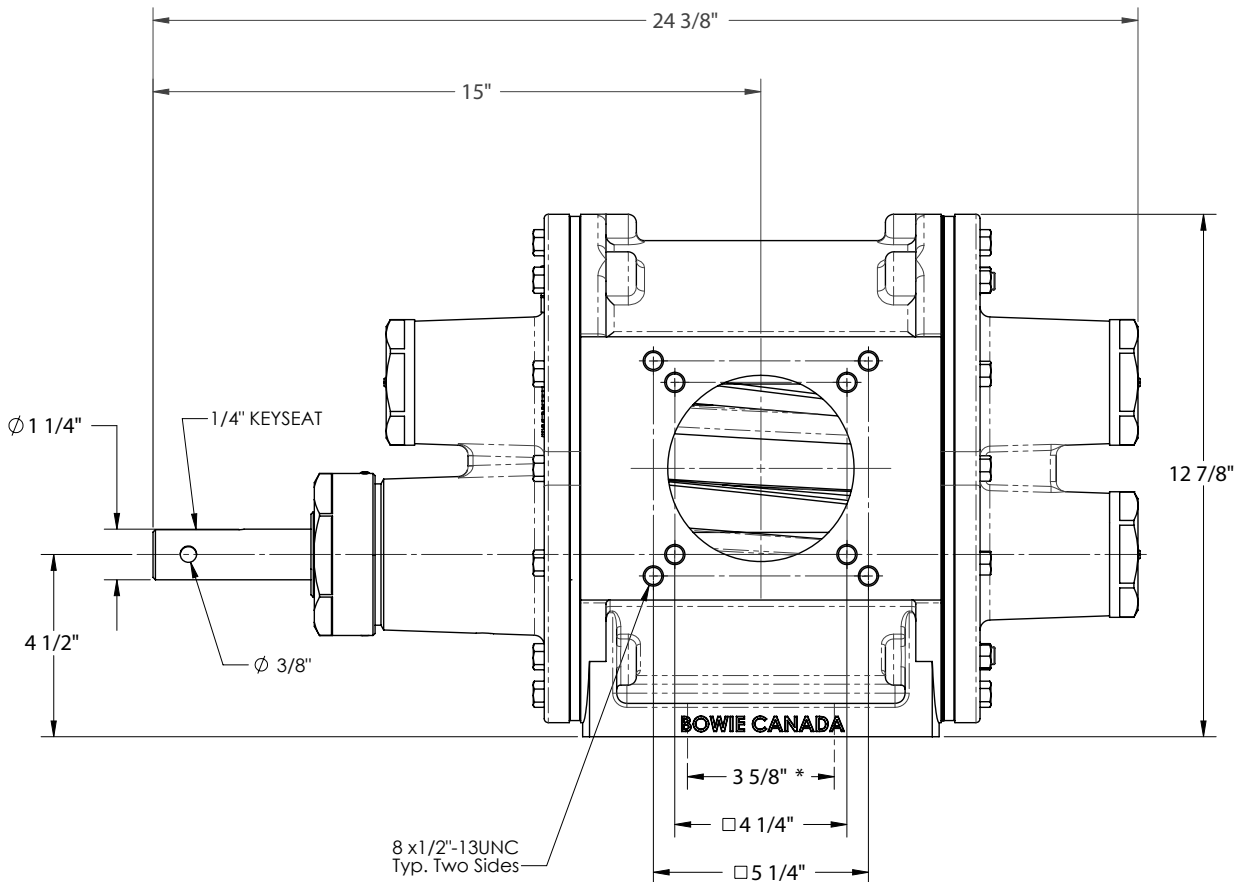
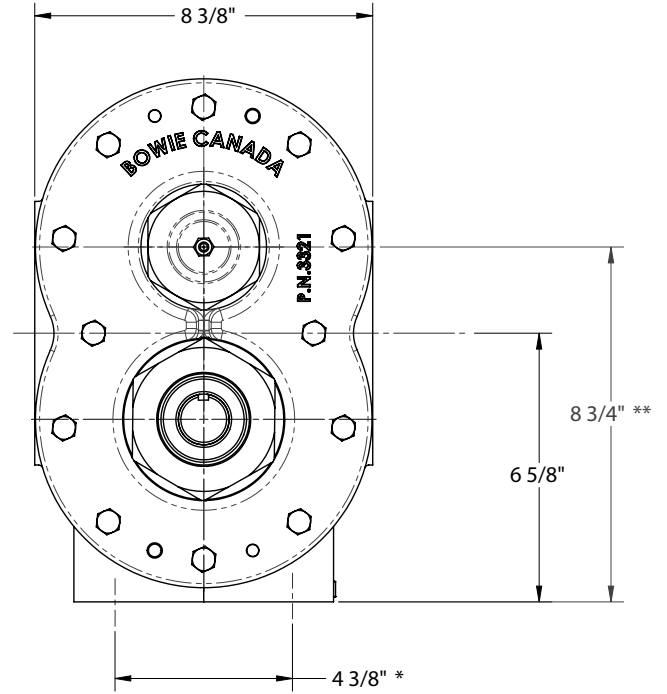
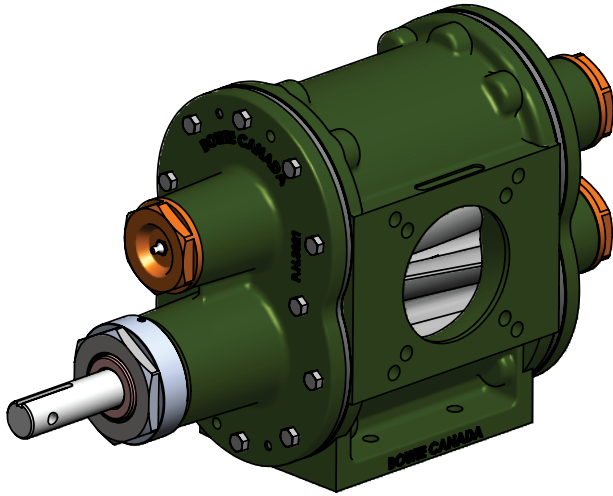

* BASE BOLT PATTERN 4 x 1/2-13 UNC;
** DRIVE "ON TOP" APPLICATION IS AVAILABLE;

"LEFT" & "RIGHT" APPLICATIONS ARE SHOWN;

